

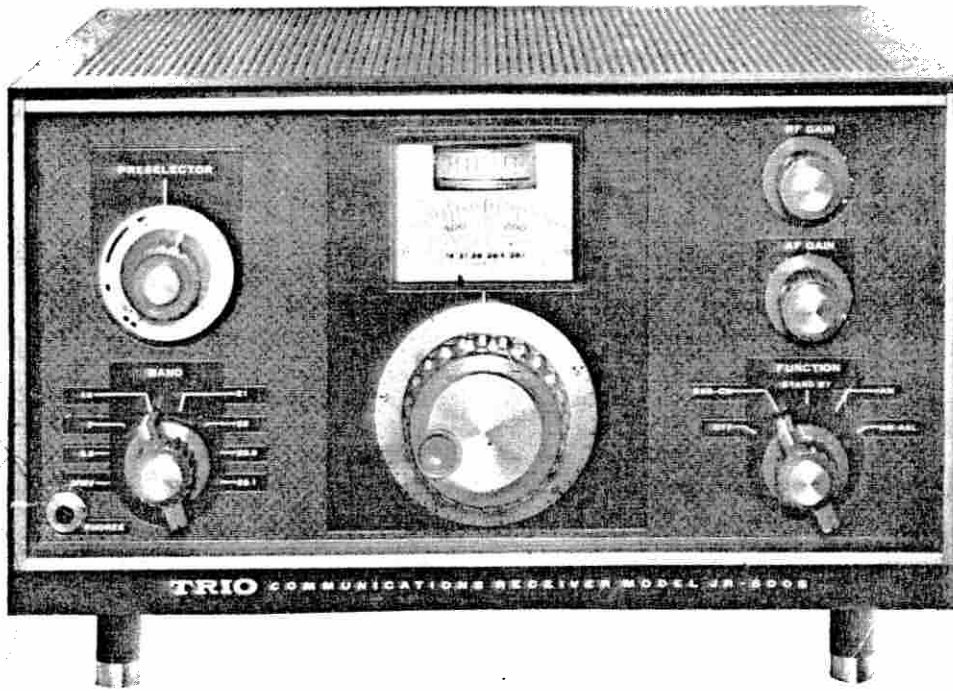

TRIO



COMMUNICATIONS RECEIVER

MODEL **JR-500S**

INSTALLATION MANUAL

DISTRIBUTOR

TRIO JR-500S

The TRIO JR-500S is a high performance communications receiver made especially to cover the amateur bands. It utilizes a crystal controlled double heterodyning circuitry and provides high sensitivity and good stability.

SPECIAL FEATURES

1. This receiver covers all the amateur bands between 3.5 and 29.7 MHz. It will also receive the 10 MHz frequency standard signal.
2. The dial features an anti-backlash double gear construction. It is direct reading down to 1 kHz. Precise tuning of all signals including SSB is assured by the large, geared down dial speed ratio of 28:1.
3. Superior stability performance is obtained by the use of a crystal controlled first local oscillator, and also a VFO type 2nd oscillator.
4. Frequency drift is practically nil due to the use of a solid state VFO circuitry.
5. Superior selectivity performance is obtained by the use of a mechanical filter in the IF circuitry.
6. The receiver incorporates a built-in product detector which assures good reception of SSB and CW.
7. The BFO circuit utilizes a crystal controlled oscillator for superior performance.
8. The VFO circuit is equipped with convenient output terminals so that it can also be used as a VFO for the transmitter.
9. Besides the 8 ohm impedance speaker terminals at the audio output, the receiver has a 500 ohm impedance phone jack. 500 ohm impedance output terminals are also available for recording purposes, and as an output source for RTTY connections.
10. The receiver incorporates AVC, ANL, and S-meter circuits.
11. The receiver is equipped with an OFF-ON switch, which can be used when it is desired to add a calibration circuit.
12. A Coaxial cable connector receptacle may be easily installed if desired.
13. The receiver is equipped with remote control terminals which facilitate connections to the transmitter.

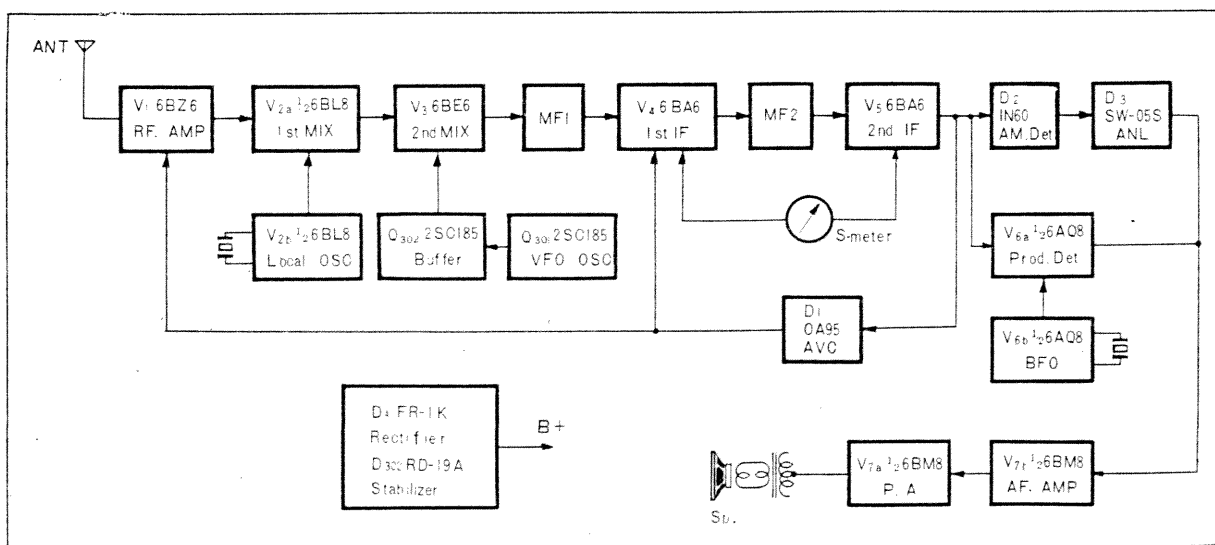

Figure 1 — Block Diagram

CIRCUIT THEORY

The circuit components of the receiver are as shown in the block diagram in Figure 1. The 3.5 to 29.7 MHz amateur band signals are converted by the 1st Mixer to the 1st IF frequency of 8.9 — 9.5 MHz, then again converted by the second mixer to 455 kHz.

RF AMPLIFICATION

In conjunction with the RF tuning circuit, this stage selects and amplifies weak radio signals to the necessary level. It also improves Signal to Noise and image rejection ratios. High gain and stable RF amplification are obtained by utilizing a high gm, remote cut-off 6BZ6 tube for the RF stage. Use of a high Q coil in the tuning circuit has contributed to exceptional selectivity and superior S/N ratio. AVC voltage is fed to the control grid of the RF tube for automatic gain control. A potentiometer for RF gain control is placed in the cathode circuit.

FIRST MIXER

This circuit converts the 3.5 — 29.7 MHz incoming signal to the 1st IF frequency of 8.9 — 9.5 MHz. A low noise, high gain, grid-feed type pentode is used for the mixer. The local oscillator is crystal controlled to eliminate frequency drift and assure complete stability.

For frequency ranges between 3.5 to 7 MHz, heterodying is achieved on the upper side, while it is carried out on the lower side for the frequency range between 14 and 29.7 MHz. The tuned plate circuit is ganged with the variable capacitor of the VFO oscillator.

2ND MIXER AND VFO

The Second Mixer converts the 8.9 — 9.5 MHz 1st IF to 455 kHz. A 6BE6 tube is used for this purpose, the signal being fed to G3 and the VFO output to G1.

The VFO circuit which is transistorized has been specially designed to minimize frequency drift. The power supplied to the VFO circuit is regulated by a stabilizer diode. An emitter

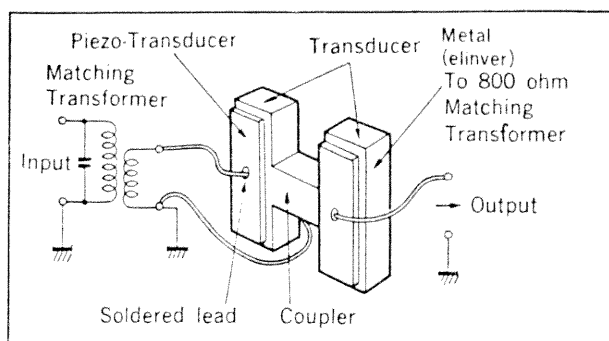

Figure 2 — Mechanical Filter

follower in the output circuit eliminates any possibility of adverse external effects. A linear frequency variable capacitor is used in this oscillator circuit. The VFO output frequency ranges from 8.4465 to 9.0465 MHz.

IF AMPLIFICATION

The purpose of the IF amplifier stages is to provide sufficient amplification, and at the same time to assure extremely sharp selectivity by enabling the cut-off of closely adjacent signals. This is achieved in this receiver by two stages of IF amplification utilizing 6BA6 tubes, and high Q mechanical filter circuits.

The mechanical filter, which achieves selectivity by changing the incoming signal to mechanical vibrations which are then filtered in a special resonant circuit, achieves ideal selectivity performance because of the extremely high Q of the filter circuit. Details of the mechanical filter are shown in Figure 2.

Besides the above functions, the IF amplifier also helps to achieve automatic gain control with the AVC voltage that is supplied to it.

S-METER CIRCUIT

The S-Meter is inserted across the cathode circuits of the two IF amplifier tubes. Under no signal conditions, the zero adjust potentiometer is adjusted for balance, and no current flows through the S-meter. As AVC voltage is fed only to the first IF stage, and not to the second, an incoming signal results in a drop in plate current in the first stage and a consequent

drop in cathode current. However, the cathode current of the second I.F. remains unchanged, thus destroying balance and resulting in current flow through the S-meter. This indicates the intensity of the incoming signal.

AVC CIRCUIT

The negative voltage obtained after rectification of the IF output by a diode is used as the AVC supply voltage. This is fed to the RF amplifier tube and the grid of the first IF tube. An increase in signal strength results in an increase in negative bias of the amplifier tube, thus decreasing gain. Conversely, weak signals cause greater amplification, resulting in maintenance of a constant receiver output level, regardless of input signal variations.

C bias can also be inserted into the AVC circuit through the remote control terminals for standby operation of the receiver.

ANL CIRCUIT

Automatic noise limiting operation is achieved through the use of a silicon diode, series type ANL circuit. When a pulse type interference

accompanies an incoming signal, the diode in the ANL circuit operates in cut-off position for very brief time intervals. Thus, it effectively acts as a gate to shut out undesirable noise peaks.

DETECTOR AND AUDIO AMPLIFICATION

Audio detection is achieved by the use of a linear diode detector, while a triode product detector is used for SSB and CW detection. The BFO output and the incoming signal are fed to the grid of the triode used in the product detector circuit. This circuit is specially designed to be free from distortion regardless of signal intensity.

6BM8 tubes are used in two stages of audio amplification to obtain a maximum power output of 1 watt.

BFO CIRCUIT

This circuit is necessary to produce a beat or carrier reinsertion voltage to enable reception of SSB or CW, and its circuit requirements call for a very stable oscillator. Thus, a crystal controlled oscillator is used here in this receiver, assuring absolutely no frequency drift.

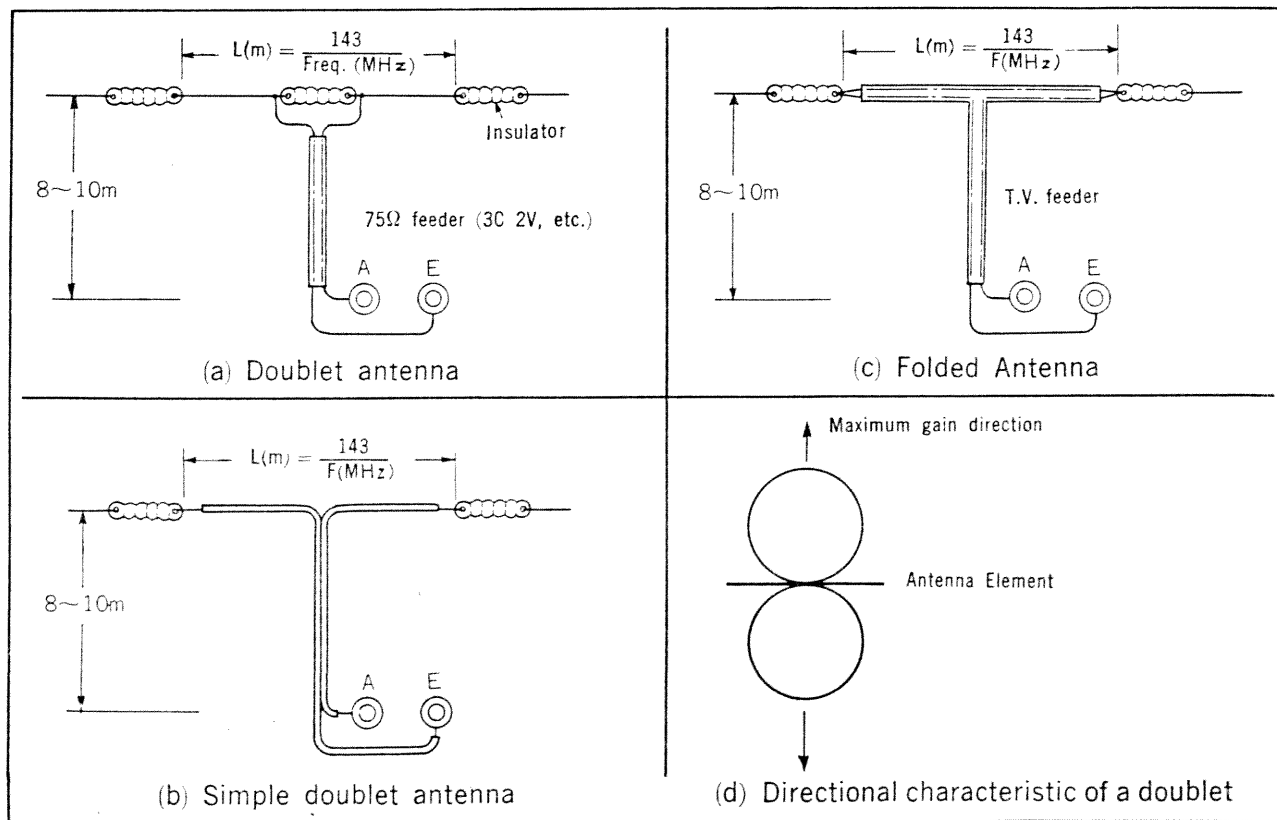

Figure 3 — Erecting the Antenna

ANTENNA AND SPEAKER

A good antenna is necessary to obtain the best performance from any receiver.

Most amateur radio stations use a single antenna for both transmission and reception. An efficient transmitting antenna can be said to be a good receiving antenna. An example of a doublet antenna, which is effective and easy to erect, is shown in Figure 3.

If the operating frequency is known, the overall length of a doublet antenna can be calculated as follows.

$$(\text{Length in meters}) = \frac{143}{\text{Frequency in MHz}}$$

Thus, the above formula can be used for calculating the overall length of a doublet antenna for use on the 7 MHz ham band as follows.

$$\frac{143}{7} = 20.4 \text{ meters.}$$

Since the overall length of this doublet antenna is 20.4 meters, the length of each element then should be 10.2 meters. A coaxial cable lead-in can be connected to the center of the doublet and brought in to the receiver antenna input. Since a doublet antenna has directional properties, it should be stretched at right angles to the line of direction in which optimum performance is desired.

SPEAKER

A permanent dynamic speaker (4-16 ohms) without an output transformer should be used for connection to the receiver. Receiver output terminals with impedances of 8 ohms and 500 ohms are available. The speaker should be connected to the 8 ohm terminals. It will be automatically cut off when head phones are inserted into the Phone jack. The 500 ohm output terminal can be used for RTTY connections or for connections to a tape recorder.

HEAD PHONES

Although low impedance, magnetic type headphones are recommended, any other type may be used for all practical applications.

CONTROLS AND THEIR FUNCTIONS (See page 6)

1. FUNCTION

This switch controls the various functions of the receiver, as explained below, when set in the following positions.

OFF — At this position AC power is cut off.

This control should always be set in this position when the receiver is not in use.

SSB-CW — This is the position to use for SSB and CW reception.

STAND BY — This position cuts off the B supply voltage, making the receiver temporarily inoperative during transmission periods.

AM — Set switch to this position for AM reception.

AM-ANL — Set switch to this position when static, automobile ignition noise or pulse type interference hampers AM reception.

2. AF GAIN

This is the volume control. Turn to the right in a clockwise direction to increase volume, and to the left to decrease volume.

3. RF GAIN

This is the receiver sensitivity control. For ordinary reception it should be set at maximum (extreme clockwise position). It should be adjusted only in such cases where an extremely strong signal from a local station may overload the receiver, causing distortion and a resultant decrease in sound level. This control is equipped with a push-pull OFF ON switch (not used) which can be used when a calibration circuit is built into the receiver.

4. TUNING

This is the Tuning Knob. One revolution controls a 50 kHz linear dial reading. Each indication line on the knob indicates 1 kHz. For frequencies between 3.5 to 7.3 MHz, readings are made against the red colored figures, while the black figures are used for frequencies between 14 and 29.7 MHz.

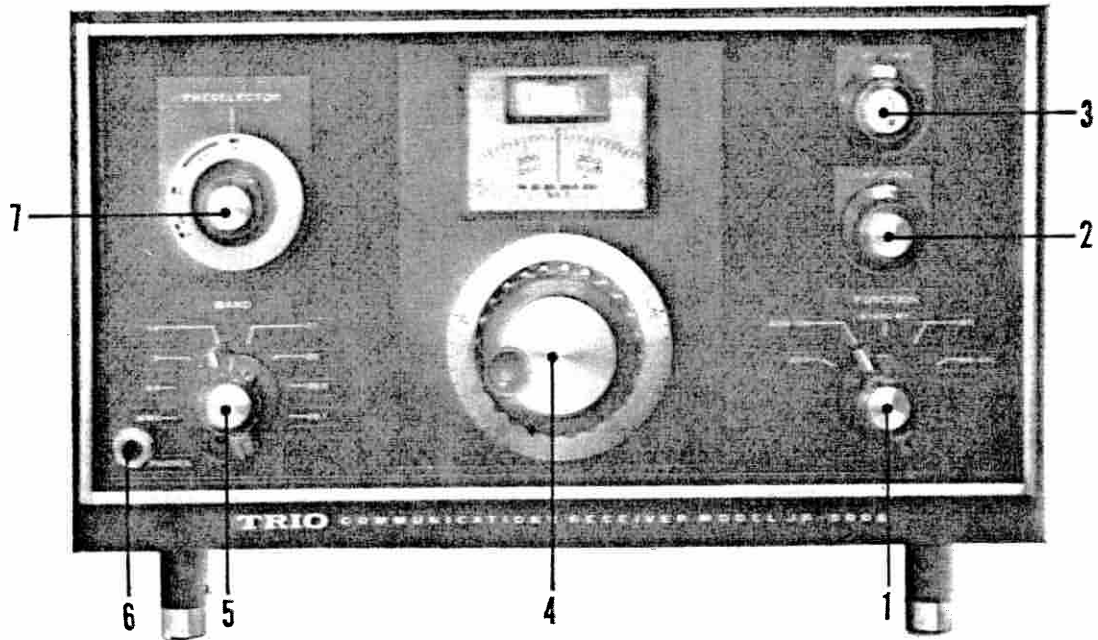

Photo 1 — Front View

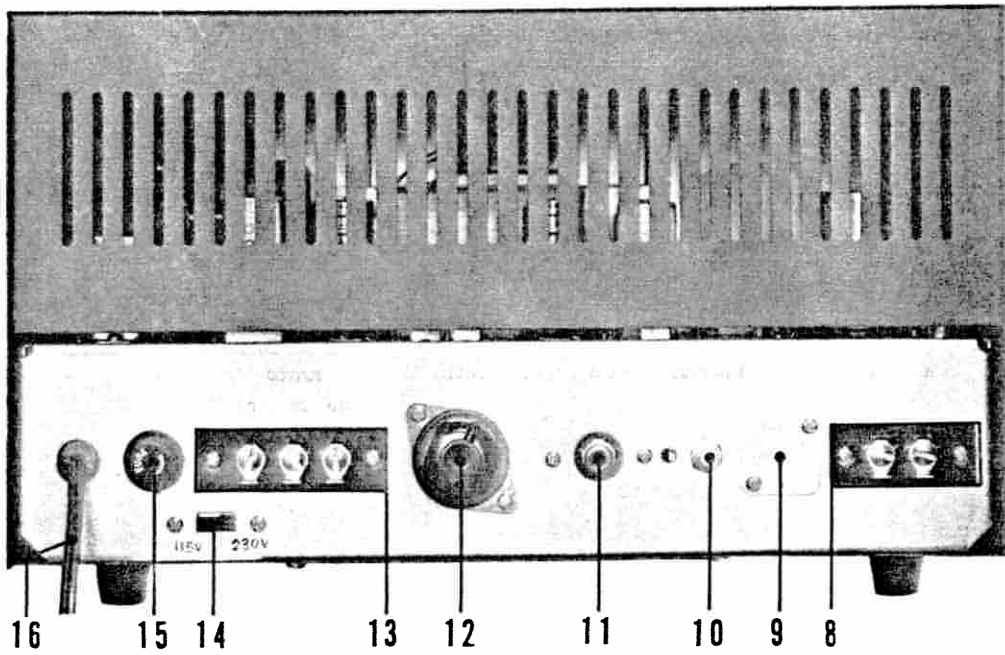

Photo 2 — Back View

5. BAND

This is an 8-position Band Change Switch to cover the amateur bands from 3.5 to 29.7 MHz and the 10 MHz standard frequency signal in 8 steps.

6. PHONES

This is the headphone jack, the use of which will cut off speaker operation and enable private listening. A headphone plug is supplied with this receiver.

7. PRESELECTOR

This controls a variable capacitor which permits matching of the Antenna and the RF circuit. It will provide maximum receiver sensitivity when the control is set close to the band which is being received.

8. A, E

The antenna and earth lead-in should be connected here. Input impedance is 50 to 75 ohms.

9. AUXILIARY HOLE

This is an extra hole provided for easy installation of a M-type coaxial cable receptacle when a coaxial cable is used to bring in the antenna.

10. ZERO ADJ

This controls zero adjustment of the S-Meter. It should be adjusted for zero indication of the S-Meter with the antenna disconnected and no signals received.

11. VFO OUTPUT

VFO output is available here. Its frequency is 8.4465 to 9.0465 MHz and the output voltage is approximately 1 volt.

12. REMOTE

This is a socket for remote control operation when the receiver is used in conjunction with a transmitter. It is not used when only the receiver is operated. In such a case, the plug should be left untouched in the socket.

13. OUTPUT

Audio output is available here. Two output impedances, 8 ohm and 500 ohms, are provided.

15. FUSE

When it becomes necessary to replace the fuse, be sure to use 2 ampere fuses of a similar type.

14. AC POWER SELECTOR

This receiver is equipped with an AC Power Selector Switch located at the rear of the chassis. The receiver will operate from 115V AC line sources when this switch is switched to the left side, and 230V AC line sources when switched to the right side.

CAUTION — Be sure it is switched in the proper position before inserting the line cord.

16. LINE CORD

OPERATING INSTRUCTIONS

1. How to Adjust the S-Meter

Set the receiver in operation. After adjusting RF gain to maximum sensitivity, short the Antenna and Earth terminals, A and E. Now adjust the Zero Adjust Control at the chassis rear for zero reading of the S-Meter.

2. To Receive

FUNCTION — Switch to SSB-CW for reception of SSB and CW, and to AM for AM reception.

When pulse type interference hampers AM reception, switch FUNCTION to AM-ANL.

BAND — Set this switch to the desired band.

RF GAIN — Set this control for maximum sensitivity (full clockwise position).

AF GAIN — Adjust this control for desired volume level.

PRE SELECTOR — Turn this control and set the indicator near the desired band. Adjust for maximum receiver sensitivity.

TUNING — Set the dial indicator to zero. Then push the outer dial lightly and turn it so that it also is set at zero. Now the indications on the outer dial can be directly read down to 1 kHz. Read the figures in red for frequencies between 3.5 to 7.3 MHz, and the black figures

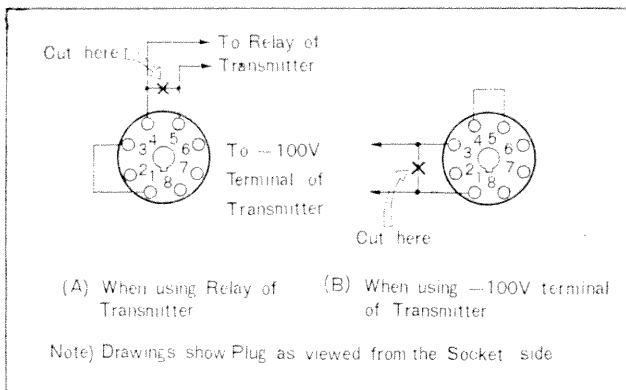

Figure 4 — Connections for Remote Control

for frequencies between 14 and 29.7 MHz. The 10 MHz standard signal can be received when the dial reading is at ▲ mark.

For SSB reception, the dial should be turned very slowly. Excessive signal strength during SSB reception may make demodulation difficult. In such cases decrease the RF GAIN by turning this control to the left. Smooth demodulation will then be possible.

CONNECTIONS FOR REMOTE CONTROL OPERATION

When a receiver is used in conjunction with a transmitter, the ordinary practice is to use the standby switch of the transmitter to control the receiver. Connections should be made as shown in Figure 4 (A) when only the relay circuit is available at the transmitter. Connections should be made as shown in Figure 4 (B) when a -100 volt C bias is available at the transmitter side for making the receiver inoperative during transmission.

CIRCUITS WHICH MAY BE ADDED TO THE RECEIVER

1. CALIBRATION CIRCUIT

A calibration circuit with a crystal controlled oscillator serving as a marker generator will enable accurate calibration of the receiver's dial readings. It may be a useful addition for your receiver. Fixed crystals with frequencies of 100 kHz, 500 kHz or 1 MHz are usually used for this purpose.

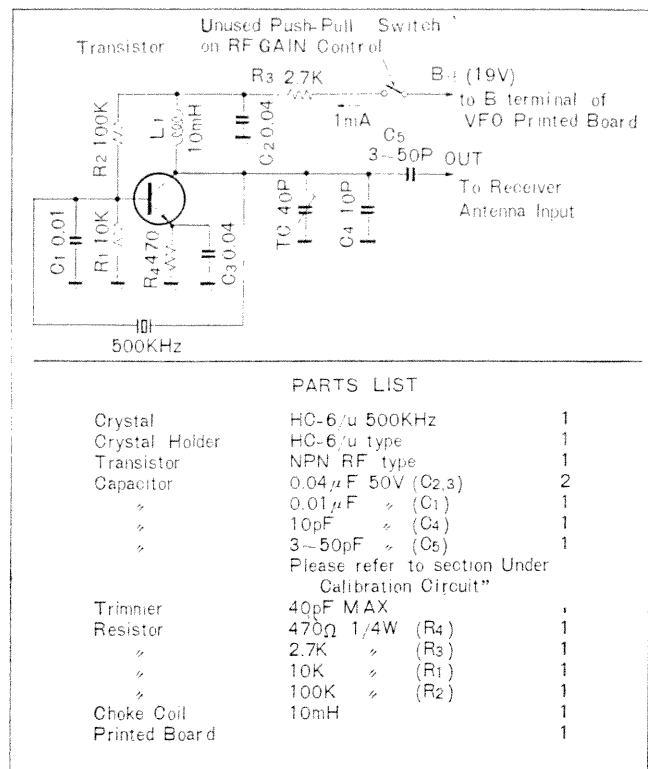

Figure 5 — Calibration Circuit

Figure 5 shows an example of a calibration circuit which uses a 500 kHz crystal oscillator. A NPN type transistor should be used because of the plus potential B power supply voltage. Coupling condenser C should be chosen so that the beat note is only weakly heard on the 29.1 MHz band. If the calibration signal is too strong (coupling to antenna excessive), the calibration beat notes will be heard in many places other than at 500 kHz ranges. On the other hand, in the case of insufficient coupling, it will not be possible to hear the beats in the high frequency ranges.

2. CHANGING THE LEGS

The receiver comes to you equipped with Hyzex legs which are 35 mm high. Depending on your particular installation requirements, these legs may easily be changed with shorter 15 mm legs which are also supplied with the receiver.

The 35 mm legs can be removed by turning them to the left. Attachment of the 15 mm legs can be made with the 4 screws which are supplied for the purpose.

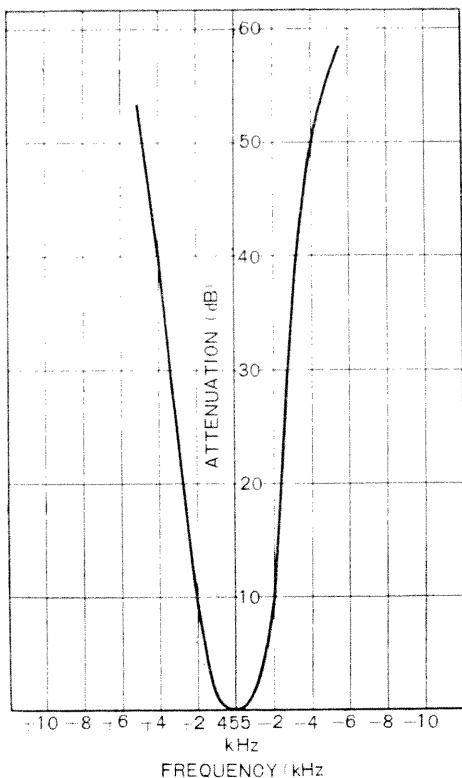

Figure 6 — Selectivity

ALIGNMENT

If realignment of the receiver should become necessary, the steps outlined in page 10 should be followed. During alignment, a VTVM can be connected to the speaker terminals, or the S-Meter can be used to obtain output level indications. It is obvious that a very accurate Signal Generator should be used for alignment work.

SPECIFICATIONS

FREQUENCY RANGE:

Band	Frequency in MHz
3.5	3.5 — 4.0
7	7.0 — 7.3
14	14.0 — 14.35
21	21.0 — 21.45
28	28.0 — 28.5
28.5	28.5 — 29.1
29.1	29.1 — 29.7

RECEPTION:

AM, SSB, CW

SELECTIVITY:

± 1.5 kHz at -6 dB
 ± 6 kHz at -60 dB

SENSITIVITY:

1.5 mV for 10 dB S/N Ratio at (14 MHz)

IMAGE RATIO AND IF REJECTION:

More than 40 dB at 14 MHz

MAXIMUM POWER OUTPUT:

1 watt

TUBES AND TRANSISTORS USED:

7 Vacuum tubes, 2 transistors, 5 diodes

POWER CONSUMPTION:

65 watts

WEIGHT:

18 lbs. (8 Kg.)

DIMENSIONS:

13" Wide \times 7" High \times 10" Deep.

SPECIAL CIRCUITS:

ANL, Crystal BFO, S-Meter, AVC

CONCERNING MAINTENANCE

1. REPLACING THE FUSE

In case of fuse failure, be sure to make replacements with a similar type two ampere rated fuse. When the fuse holder is turned to the left, the lid comes off and the fuse can be easily removed. Before replacing a blown fuse, a check must be made to find the cause for it. If trouble is located, repairs must be made first.

2. PILOT LAMP

Since an 8V swan-base type lamp is used for illuminating the dial, replacements should be made with similar type lamps.

3. RESISTORS

When a resistor becomes defective, it can be replaced with another which is within $\pm 10\%$ of its value. For example, a 300 ohm resistor can be used to replace one of 330 ohms without causing adverse effects.